

**TICKET
TO THE
MOON**

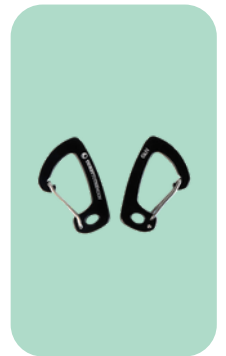

Workbook

2025

CONTENT LIST

**TTTTM IN A
NUTSHELL 03**

**TRAVEL LINE
HAMMOCKS 06**

TECHNICAL LINE 16

HOMELINE 24

**HAMMOCK
ACCESSORIES 28**

**ATTACHMENT
KITS 36**

**UPCYCLED
COLLECTION 48**

**LIFESTYLE
PRODUCTS 62**

POINT OF SALE 68

COMMUNITY 72



At TICKET TO THE MOON, we are on a mission to empower dreamers and those on the path to becoming dreamers. We are committed to nurturing an environment that inspires and transforms, helping individuals to unlock their utmost potential. Our goal is to simplify and enrich the lives of our fellow earth-dwellers by providing enduring, sustainable solutions crafted with meticulous attention to detail and a passion for excellence.

REDUCING OUR CARBON FOOTPRINT

We are dedicated to raising awareness about critical global issues like sustainability and ethical production. Our operations are designed to foster community progress while honoring and reinforcing the local social fabric. The majority of our workforce and materials are sourced from Indonesia - our cherished hub and sanctuary. We ensure that all our adult team members are treated with respect and fairness. Our organisational culture is characterized by genuine, humane, and equitable values, ensuring that every TICKET TO THE MOON family member benefits from proper working conditions, social security, pensions, and wages well above the regional norm. A substantial part of our profits is annually shared with our employees, proportionate to their time with us, fostering a happy community united by our collective journey towards excellence. We live, manufacture and work in Bali, our home. We are committed to eco-conscious practices,

using local materials and investing in innovative re- and upcycling techniques to minimize our environmental impact. This applies to our product designs, packaging, and local manufacturing processes. Any leftover fabric is transformed into eco-friendly items or recycled for future use. Our dedication to reducing our carbon footprint is encapsulated in our principle: “nothing is wasted because we care.”

OUR METHOD

We firmly believe that excellence emerges when collaboration, integrity, fairness, enjoyment, and sustainability are the cornerstones of our behavior.. Guided by these principles, we strive to craft a unique TICKET TO THE MOON experience for you by meticulously designing and creating our products in-house.

This approach ensures that we deliver top-notch merchandise, tailoring each item to meet your specific needs at reasonable prices. Our commitment to achieving outstanding results is rooted in our deep belief in teamwork. We embrace and thrive on diversity within our global, multicultural squad. Our uncompromising pursuit of perfection, through continuous product innovation and scrutiny, positions us at the forefront of hammock innovation. Moon Hammocks are meticulously handcrafted by our skilled artisans in Bali, including some who have been part of our journey since its beginnings.

FAIR PRODUCTION



Our long-term goal is to raise awareness of larger global challenges such as sustainability and fair production issues. In all our operations we aim to bring advancement to the community while respecting and supporting the local social structures. ACT LOCAL! The main part of our helpers and materials originate from Indonesia — our beloved nest and home. Ticket to the Moon is not only a brand but also a factory! We have 200+ team members on 4000m2 factory floor, and are proudly crafting all products on the island of Bali.

At Ticket to the Moon, we are committed to providing products that are not only innovative and high-performing but also kind to both your skin and the environment. Our fabrics are entirely PFC-free and boast the OEKO-TEX® Standard 100 certification. This means that our fabric has been tested for harmful substances and are harmless in human ecological terms. This commitment ensures that our products are safe and healthy for your skin, making them ideal for everyone, including children and those with sensitive skin.

MINIMIZING OUR FOOTPRINT

Join us in reducing our impact on the planet. With a commitment to local sourcing, resource-efficient production, and innovative upcycling methods, we offer durable, high-quality products of ecological value. Experience the benefits of local value creation and thoughtful packaging design. Every leftover material finds new life in our upcycled collection or is recycled into fresh fabrics. Explore sustainable practices and make a difference today.



MEMBER

Since day one, we have defined ourselves not only as a manufacturer of feel-good products, but also as an advocate of socially responsible production conditions and fair trade at all levels. Together with the fair trade movement, we share the vision of more justice, transparency and sustainability in international trade (World Fair Trade Organization, 2009).

As a recognized partner of the Austrian, South Tyrolean and German world stores we guarantee a number of criteria at every stage of the production process, which include appropriate working conditions and fair trade practices as well as the protection of the environment.

We have been an official WFTO member since 2023. Honestly and mindfully, we are heading full steam ahead towards our utopia - for our employees, for our suppliers and for our planet.



“We live, produce and work in Bali, our home”

TRAVEL LINE HAMMOCKS

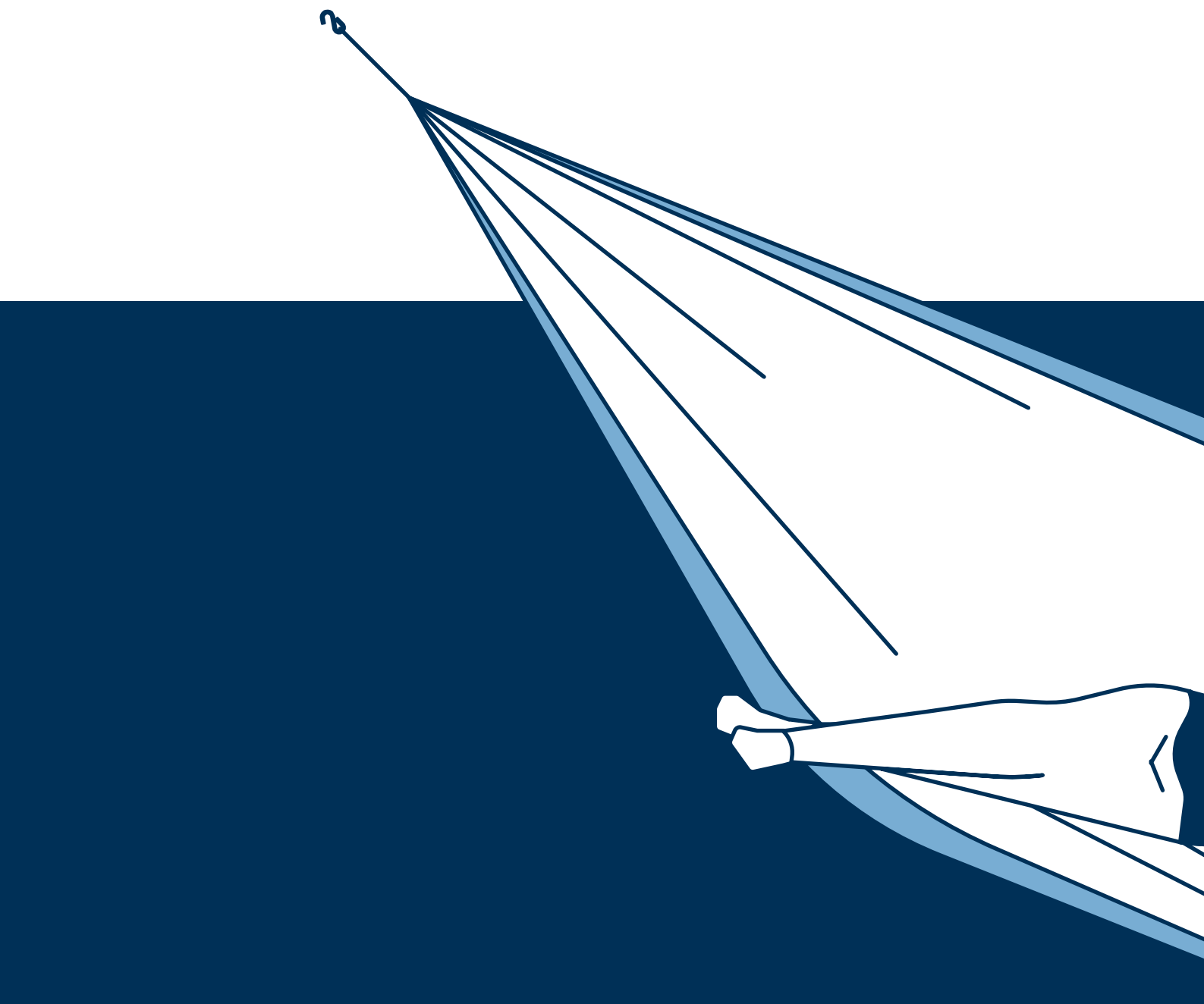

Compact | Original | King Size | Mini Set |
Honeymoon Set | Mammock Set



PARACHUTE HAMMOCKS



Since 1996, TICKET TO THE MOON has been the original parachute nylon hammock manufacturer. Designed and created by travellers for travellers, our hammocks are tested in every climate around the world and are equally suitable for a serious adventurer's trip as well as daily use. Once you try a Moon Hammock, you'll never miss your tent again! Enjoy a comfortable sleep and «off the ground» protection from water, insects and small animals. Ticket to the Moon parachute hammocks have many handy attributes: lightweight yet robust, spacious but portable, set up and takedown less than a

minute, rot-resistant, machine washable and fast drying. The elastic and breathable nylon adjusts perfectly to your body contours, allowing for optimal blood circulation and relief. Hanging a hammock is often allowed, whereas pitching a tent is not. Our hammocks are delivered with stainless steel S-hooks or high-grade aluminium carabiners. Our hammocks are ideal for every occasion — whether you are travelling, spending a day in the park with friends, or just staying at home. Play, relax, take a nap or sleep all night in your Moon Hammock!



EXPRESS SETTING BAG

This unique and versatile feature comes along with all our hammocks and adds tremendously to their functionality. It enables you to set up and take down the hammock within no time!

COMPACT

(TMC)



Dark Green
(TMC05 / **TMCR05** ♻️)



Brown
(TMC08 / **TMCR08** ♻️)



Turquoise
(TMC14)



Army Green
(TMC24 / **TMCR24** ♻️)



Burgundy
(TMC34)



Emerald Green
(TMC36)



Royal Blue
(TMC39)



NEW! Sand
(TMC70)



NEW! Jade Green
(TMC73)



NEW! Plum
(TMC78)

- Durable
- Great value
- Single piece of fabric
- Easy to use
- Entry-level hammock for young and smaller users.

Material	Parachute nylon 70D 64 g/m ²
Weight	500 g
Length hook to hook	320 cm
Width	155 cm
Max. load	200 kg
Fabric length	300 cm

Breaking strength:	
Hook	>380 kg
Carabiner	>580 kg



Express Bag



S-Hook

ORIGINAL

(TMO)



Dark Green & Army Green
(TMO0524 / **TMOR0524** ♻️)



Aqua & Dark Grey
(TMO1503)



Army Green & Brown
(TMO2408 / **TMOR2408** ♻️)



NEW! Army Green & Green Apple
(TMO2475 / **TMOR2475** ♻️)



Burgundy & Dark Yellow
(TMO3437)



Orange & Dark Grey
(TMO3503)



Emerald Green & Green
(TMO3611)



Royal Blue & Turquoise
(TMO3914)



NEW! Mint & Ice Brown
(TMO7172)



NEW! Plum & Peach
(TMO7876)

- Best-selling every-day hammock
- Wide and colourful
- Amazing all-night sleep
- Featuring triple stitching
- Durable and reliable companion



Express Bag



S-Hook

Material	Parachute nylon 70D 64 g/m ²
Weight	600 g
Length hook to hook	320 cm
Width	200 cm
Max. load	200 kg
Fabric length	300 cm
Breaking strength:	
Hook	>380 kg
Carabiner	>580 kg

KING SIZE

(TMK)



Dark Green & Army Green
(TMKo524 / **TMKR0524** ♻️)



Navy Blue & Navy Blue
(TMKo606)



Brown & Brown
(TMKo808 / **TMKR0808** ♻️)



Aqua & Dark Grey
(TMK1503)



Army Green & Brown
(TMK2408 / **TMKR2408** ♻️)

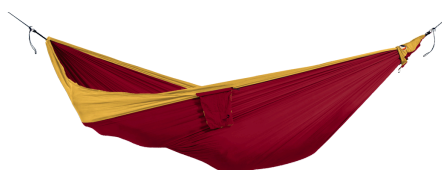

Burgundy & Dark Yellow
(TMK3437)



Emerald Green & Green
(TMK3611)

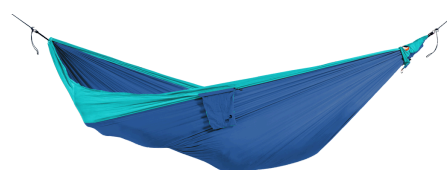

Royal Blue & Turquoise
(TMK3914)

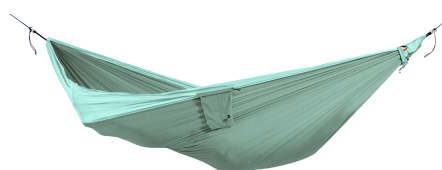

NEW! Jade Green & Mint
(TMK7371)

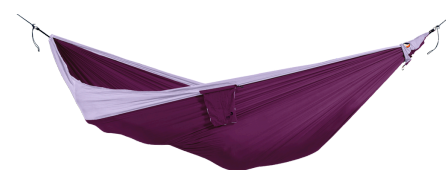

NEW! Plum & Light Purple
(TMK7819)

- Wider version of the Original Hammock
- Ideal for taller users and **extra flat sleeping**
- Comfort wonder
- Enough room for 2 adults



Express Bag



S-Hook

Material	Parachute nylon
	70D 64 g/m ²
Weight	700 g
Length hook to hook	320 cm
Width	230 cm
Max. load	200 kg
Fabric length	300 cm
Breaking strength:	
Hook	>380 kg
Carabiner	>580 kg

MINI SET

(TMMINI)



NEW! Dark Grey
(TMMINI03)



Dark Green 
(TMMINI05)



Emerald Green & Green
(TMMINI3611)



Plum & Light Purple
(TMMINI7819)

- Multi purpose set (Hammock, carabiners, ropes)
- Gear hammock , keeping your belongings off the ground
- Hammock for kids
- Fits under adult size hammock

Material	Parachute nylon
	70D 64 g/m ²
Weight	315 g
Length hook to hook	160 cm
Width	100 cm
Max. load	150 kg
Fabric length	140 cm
Breaking strength	>450 kg



Express Bag



6 kN Carabiners



Rope Set (2x)



HONEYMOON SET

(TMHM)



NEW! Dark Green & Jade Green ♻️
(TMHMR0573)



Burgundy & Dark Yellow
(TMHM3437)

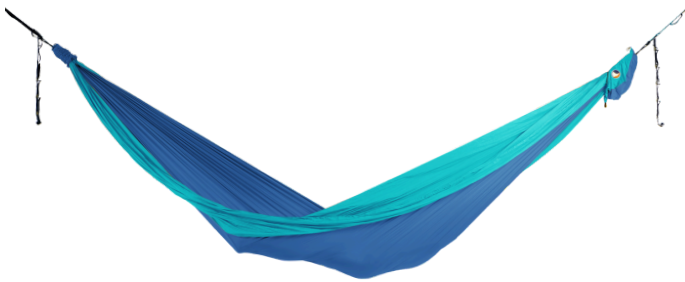

Royal Blue & Turquoise
(TMHM3914)



NEW! Green Apple & Ice Brown
(TMHM7572)

- Maximum comfort
- Easy to install
- Ideal for couples, families and larger folks.

Material	Parachute nylon 70D 64 g/m ²
Weight	1420 g
Length hook to hook	500 cm
Width	300 cm
Max. load	300 kg
Fabric length	480 cm
Breaking strength	>760 kg



Express Bag



Pair of 22 kN
Carabiner



Hammock Sleeve



Pair of Moon
Straps





WHAT A GIANT HAMMOCK!!!

- The biggest commercially available hammock
- It was designed with parties and fun in mind.

- The center of attention in any garden, event, school, gathering.
- Fits multiple adults



Mini



Compact -
Original - King
Size



Honeymoon



Mammoth



Weight	3420 g
Length hook to hook	800 cm
Width	450 cm
Max. load	350 kg
Fabric length	780 cm
Breaking strength:	>760 kg

NEW! Olive Brown & Green Apple (TMM4375)



Express Bag



Hammock Sleeve



22 kN Carabiners



Garden Strap & Ropes (2x)

Now includes Garden straps and extra strong ropes!

HAMMOCKS TECHNICAL LINE



Lightest | Lightest Pro | Pro Hammock
| Mat Hammock | ProMat Hammock

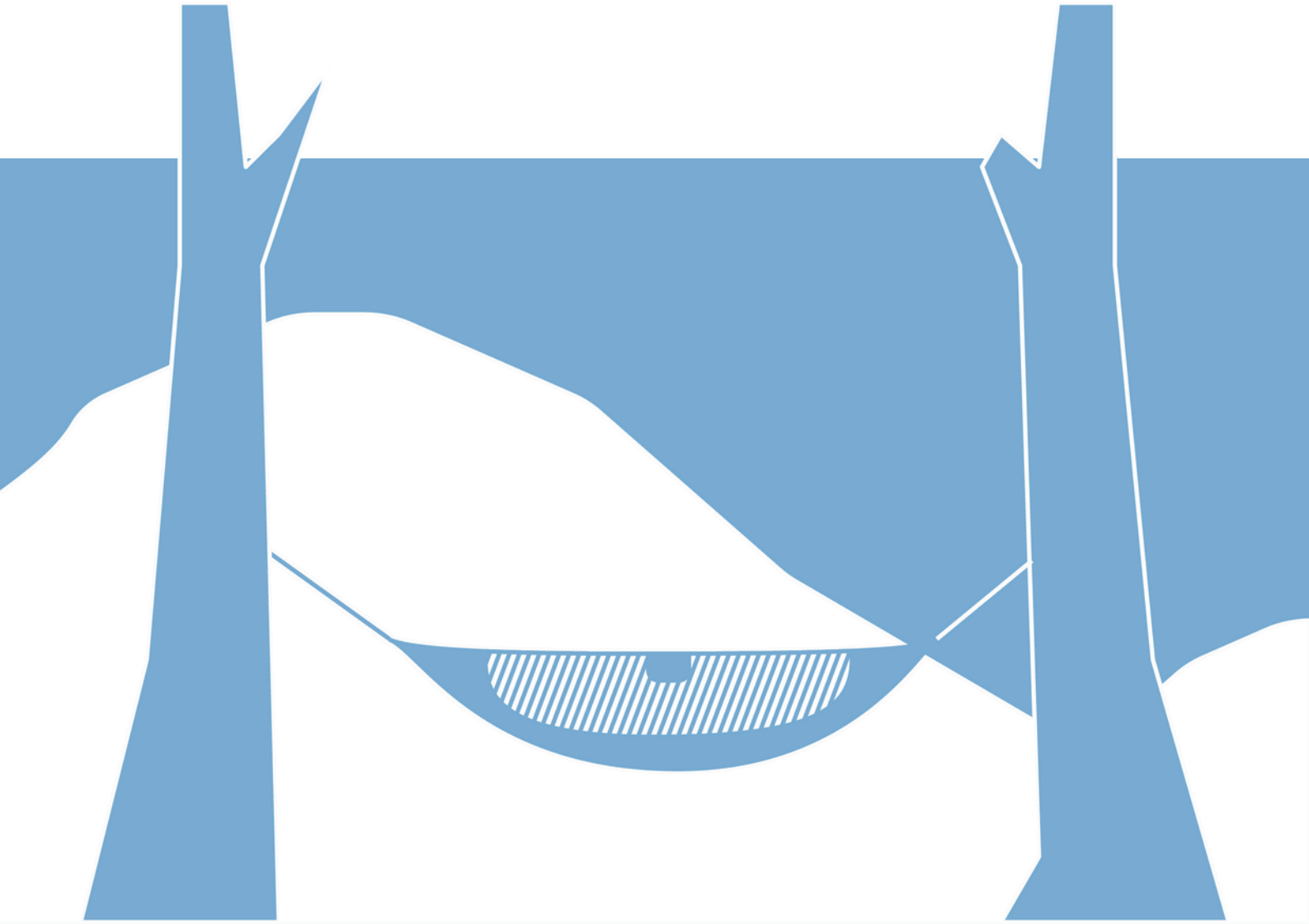



When going far, or if for you every gram counts, even a conventional travel hammock may be too heavy. Others just love the idea of having a hammock that can be truly brought anywhere, and always without having to leave other things behind. After many years of searching for an even lighter fabric that provides the level of safety and comfort typical for Ticket To The Moon, we are excited to present our Lightest Hammock.

It is an ultralight setup that is made of a locally produced, recycled high-performance crinkle nylon textile. This award-winning packing wonder with a full-length hammock body (300 cm) is suitable even for taller people without compromises in comfort. It weighs only 220 grams including the express setting bag, and with 6 kN mini-carabiners and special UHMWPE-rope, it will literally fit into your pocket.

LIGHTEST HAMMOCK

(TMLR)



Forest Green
(TMLR51)



Navy Blue
(TMLR52)



Orange
(TMLR53)

- Ultra light design
- Full length
- High-grade recycled Nylon
- Packs tiny in Express Setting Bag
- Spliced UHMWPE ropes



Express Bag



6 kN Carabiners

Material

Recycled-Crinkle
Nylon 20D
44 g/m²

Weight

220 g

Max. load

150 kg

Length

320 cm (carabiner
to carabiner)

Fabric length

300 cm

Width

140 cm

Breaking strength

>450 kg



LIGHTEST PRO HAMMOCK

(TMLPROR)



Forest Green
(TMLPROR51)



Navy Blue
(TMLPROR52)



Orange
(TMLPROR53)

- Ultra-lightweight adventurer's choice
- Insect protection with stowable mosquito net
- Tie-out elastic lines included to keep bug-net away from head and foot area
- Integrated ridgeline for extra comfort and ingenious storage organizer
- 4 zipper heads
- External loops to guide your Moonquilt
- Quick and easy installation
- Recommended attachments:
Lightest Straps (not included)

Material	Recycled -Crinkle Nylon 20D44 g/m ²
Weight	590 g
Max. load	100 kg
Length	325 cm (carabiner to carabiner)
Fabric length	310 cm
Width	140 cm
Breaking strength	>450 kg
Mosquito Net	200 holes/cm ²
Ridgeline	3 mm UHMPE 2.8 m +-10 cm



Express Bag



Pair of 6 kN
Carabiners



Mosquito Net



Ridgeline
Organizer



PRO HAMMOCK

(TMPRO)



Brown
(TMPRO0807)



Army Green
(TMPRO2424)



Burgundy
(TMPRO3407)

- Comfort-loving adventurer's choice
- Allround outdoor hammock
- New measurement making hammock lighter
- Integrated and stowable mosquito net
- **NEW!** Elastic tie-out lines keep bug net away from head and foot area
- Integrated ridgeline for extra comfort
- Organizer designed as (travel) light diffuser
- 4 zipper heads — easy bilateral access
- External loops to guide Moonquilt
- Quick and easy installation
- Includes 2 x 6kN carabiners (not included)

Material	Parachute nylon 70D 64 g/m ²
Weight	880 g
Max. load	150 kg
Length	325 cm (carabiner to carabiner)
Fabric length	310 cm
Width	170 cm
Breaking strength	>450 kg
Mosquito Net	200 holes/cm ²
Ridgeline	3 mm UHMPE 2.8 m +-10 cm



Express Bag



Pair of 6 kN
Carabiners



Mosquito Net



Ridgeline
Organizer





Army Green
(TMMAT24)



Navy Blue
(TMMAT06)

- Mattress-friendly hammock fitting all standard mattresses
- Extra insulation with the mat
- Integrated ridgeline for extra comfort
- Organizer designed as (travel) light diffuser
- Quick and easy installation
- Recommended attachments: Moon Straps (not included)

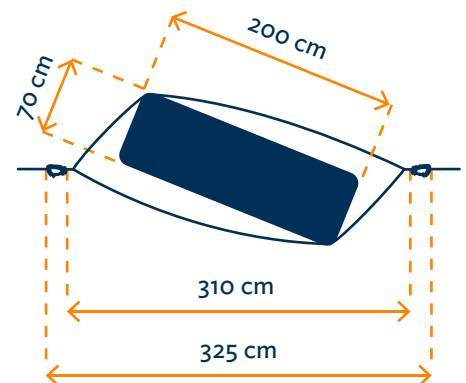

Material	Parachute nylon 70D 64 g/m ²
Material mat compartment	Recycled - Crinkle Nylon 20D 44 g/m ²
Weight	620 g
Max. load	150 kg
Carabiner to carabiner	325 cm
Fabric length	310 cm
Width	170 cm
Breaking strength	>450 kg



Express Bag



Pair of
6 kN Carabiners



Ridgeline
Organizers



PRO MAT HAMMOCK

(TMPROMAT)



Army Green
(TMPROMAT24)



Navy Blue
(TMPROMAT06)

- Allround adventure hammock fitting all standard camping mattresses (insulation)
- Integrated and stowable mosquito net
- **NEW!** Elastic tie-out lines keep bug net away from head and foot area
- Integrated ridgeline for extra comfort
- Organizer designed as (travel) light diffuser
- 4 zipper heads — easy bilateral access
- External loops to guide Underquilt
- Quick and easy installation
- Recommended attachments: Moon Straps (not included)

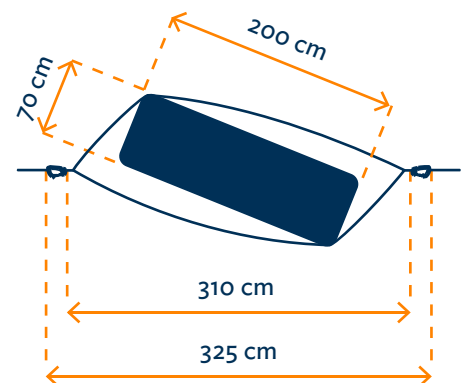

Material	Parachute nylon 70D 64 g/m ²
Material mat compartment	Recycled - Crinkle Nylon 20D 44 g/m ²
Weight	960 g
Max. load	150 kg
Carabiner to carabiner	325 cm
Fabric length	310 cm
Width	170 cm
Breaking strength	>450 kg
Mosquito Net	200 holes/cm ²
Ridgeline	3 mm UHMPE 2.8 m +-10 cm



Express Bag



Pair of
6 kN Carabiners



Ridgeline
Organizers



Mosquito Net



HOME & GARDEN LINE

Our "Home Hammock" line, a perfect addition to your home decor. This line of hammocks has arrived with upgraded features that will make your lounging experience better than ever before. The material used in the production of these hammocks is stronger, making them capable of supporting heavy weight without compromising on comfort. The "Home Hammock" line comes in six natural color tones, ensuring that you'll find a perfect match for your home. The variety in colors also makes them a perfect fit for

outdoor spaces, allowing you to enjoy the sunshine while lounging in style in your garden. In addition to the upgraded material and color options, each hammock in the "Home Hammock" line is equipped with rope, carabiner, and sleeves for easy setup and use. This means that you won't have to worry about purchasing any additional equipment to enjoy your new hammock. Simply unpack it, set it up, and relax in comfort.



Home

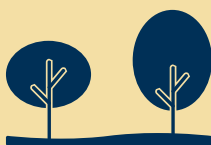

Garden



Carabiners



Elegant Pouch



Rope set (2x)



Hammock Sleeve

HOME HAMMOCK 320

(TMHOME320)



Sparkling Gold
(TMHOME 320-23)



Natural Beige
(TMHOME 320-41)



Olive Brown
(TMHOME 320-43)



Terracotta Orange
(TMHOME 320-45)



Sage Green
(TMHOME 320-47)

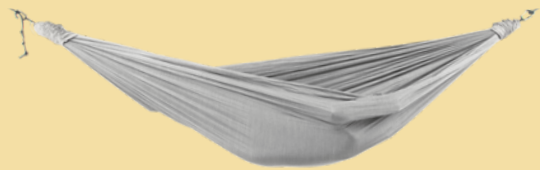

Frosty Grey
(TMHOME 320-49)

Including
Pouch & Sleeve



If you are looking for a true allround hammock that is suitable for both couples and solo usage and that combines the advantages of a parachute silk hammock with a cottony touch, you will love our 320 hammocks. With its compact pouch, it is also a viable option for you to take along on your journeys when lightweight is not of the essence.

- Premium parachute nylon
- Packed in round compact pouch
- Includes 2 × 10 kN carabiners
- Includes 2 × 260 cm pre-knotted ropes

Weight	1.22 kg
Carabiner to carabiner	320 cm
Width	230 cm
Max. load	300 kg
Fabric length	300 cm
Breaking strength	>580 kg

HOME HAMMOCK 420

(TMHOME420)

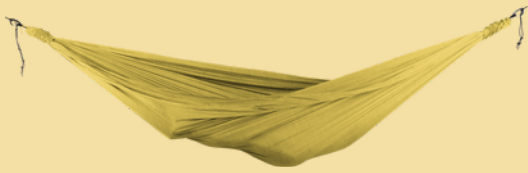

Sparkling Gold
(TMHOME 420-23)

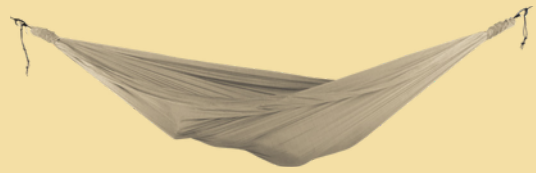

Natural Beige
(TMHOME 420-41)



Olive Brown
(TMHOME 420-43)

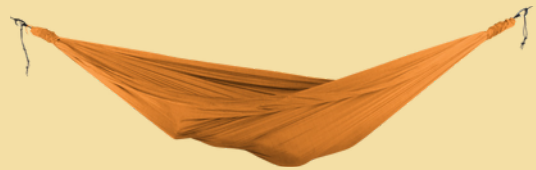

Terracotta Orange
(TMHOME 420-45)

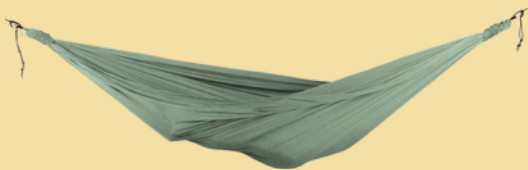

Sage Green
(TMHOME 420-47)



Frosty Grey
(TMHOME 420-49)

Including
Pouch & Sleeve



This spacious allrounder is perfect for chilling after work. It combines lavish comfort with a more versatile length that fits easier into your living room, your porch or between your favourite trees in the garden.

- Premium parachute nylon
- Packed in round compact pouch
- Includes 2 × 10 kN carabiners
- Includes 2 × 260 cm pre-knotted ropes

Weight	1.88 kg
Carabiner to carabiner	420 cm
Width	300 cm
Max. load	300 kg
Fabric length	400 cm
Breaking strength	>980 kg

HOME HAMMOCK 520

(TMHOME520)



Sparkling Gold
(TMHOME 520-23)



Natural Beige
(TMHOME 520-41)



Olive Brown
(TMHOME 520-43)

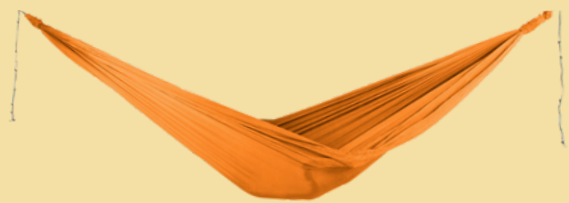

Terracotta Orange
(TMHOME 520-45)



Sage Green
(TMHOME 520-47)



Frosty Grey
(TMHOME 520-49)

Including
Pouch & Sleeve



This is probably the most comfortable hammock in our entire range — for solo dreamers as well as for families. It might just transform the naked corner in your living room into your new favourite spot around your house, or spending time out in the garden more luring.

- Premium parachute nylon
- Packed in round compact pouch
- Includes 2 × 10 kN carabiners
- Includes 2 × 260 cm pre-knotted ropes

Weight	2.28 kg
Carabiner to carabiner	520 cm
Width	300 cm
Max. load	300 kg
Fabric length	500 cm
Breaking strength	>980 kg

HAMMOCK ACCESSORIES



Moon Tarp | Fullmoon Tarp | Lightest Tarp |
Universal Bug Net 360° | UV Sleeve | Ridgeline

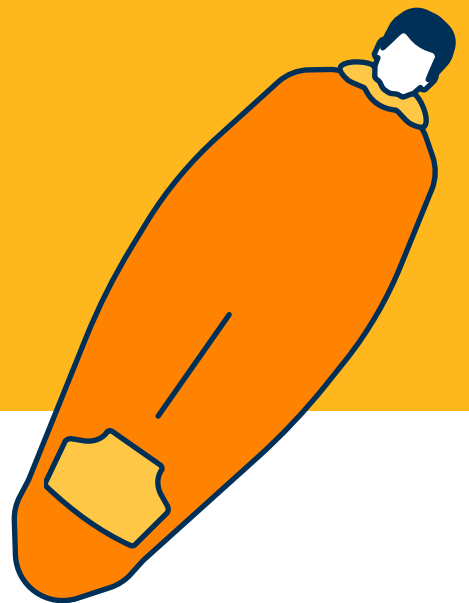

Moonquilt: Allround – Compact – Pro 650 – Pro 850 | Moonblanket: Compact – Pro 650 – Pro 850

MOON TARP

(TMTARP05)



Material	PU — coated ripstop nylon (2000 mm water column)
Min. Weight	775 g (4× guy ropes)
Max. Weight	845 g (8× guy ropes, 2× pegs)
Size	250 × 250 cm
Diagonal	350 cm
Guy rope: Blue	2× 2.5 m
Yellow	4× 2 m
Orange	2× 1 m
	(Incl. 8 carabiners & 8 quick-release-tension-buckles, 2× pegs)

This diamond-shaped tarp can be used with standard hammocks, or on its own as an instant protection from the elements. The reinforced seam-sealed corners and tie-out points make it very durable and adaptable. The blue-coloured ridgeline tie-outs come with carabiners for easy orientation and fast installation. Four additional tie-out points allow for different set-up modes using additional poles or any attachment points like branches. The adjustable guy-lines are kept in convenient breathable corner pockets for safekeeping.

- Waterproof 2000 mm
- Covers all TTTM hammocks except Honeymoon and Mammock
- Shields from rain / sun / wind
- Includes 2× Y-shaped 18 cm aluminium pegs and 8 adjustable guy lines
- Quick-release buckles for easy set-up
- Compact and lightweight
- Comes in Moon Pouch
- Contrast color ridge-line for easy set up with carabiners
- Mesh pockets for all guy-lines

FULLMOON TARP

(TMFMTARP)



Material	PU — coated ripstop nylon (1500 mm water column)
Min. Weight	585 g
Max. Weight	750 g (incl. 16x guy ropes, 6x pegs)
Size	320 × 280 cm
Diagonal	424 cm
Guy rope: Blue	2× 2.5 m
Yellow	8× 1.5 + 2× 0.35 m
Orange	4× 1 m
	(Incl. carabiners & quick-release-tension-buckles, 6x pegs)

The Fullmoon Tarp is an advanced all-weather protection that you can set up in a variety of configurations. Whether it be an A-frame tent-like shelter in challenging weather, or as a diamond tarp with maximum airflow and visibility in milder conditions — we have you covered. Thanks to the durable and high-grade 20D Sil-Nylon fabric, this tarp is not only fully waterproof and lightweight, it is also pretty quiet even in heavy rain.

- Waterproof 1500 mm
- Covers all TTTM hammocks except Honeymoon and Mammock
- Shields from rain/sun / wind
- Includes 6× Y-shaped 18 cm aluminium pegs and 12 adjustable guy-lines
- 12 Quick-release buckles for easy set-up
- Compact and lightweight
- Comes in Moon Pouch
- Contrast color ridge line for easy set-up with carabiners
- Mesh pockets for all guy-lines

LIGHTEST TARP

(TMLTARP)



Material	20D recycled ripstop sil-nylon (1500 mm water column)
Min. Weight	395 g (4× guy ropes)
Max. Weight	470 g (8× guy ropes, 2× pegs)
Size	250 × 250 cm
Diagonal	350 cm
Guy rope: Blue	2 × 2.5 m
Yellow	4 × 2 m
Orange	2 × 1 m
	(Incl. 8 carabiners & 8 quick-release-tension-buckles, 2x pegs)

Fast protection from rain, sun and wind, while cutting weight to a minimum! Install it high for maximal shadow and air-flow, or low to keep rain and wind away. The reinforced sides, corners and tie-out points make this minimalist piece of gear impressively sturdy. The Sil-Nylon 20D material enables the Lightest Tarp to offer full features, as it comes with quick-release tension buckles on all four corners, two pegs and 4 extra tie-out loops. The blue-coloured ridgeline tie-outs come with carabiners for easy orientation and fast installation.

- Waterproof 1500 mm
- Covers all TTTM hammocks except Honeymoon and Mammock
- Shields from rain/sun/wind
- Includes 2× Y-shaped 18 cm aluminium pegs and 4 adjustable guy-lines
- 8 Quick-release buckles for easy set-up
- Compact and lightweight
- Comes in Moon Pouch
- Contrast color ridge line for easy set-up with carabiners
- Mesh pockets for all guy ropes

UNIVERSAL BUG NET 360°

(TMNET)



Black
(TMNET07)



Green
(TMNET24)



White
(TMNET01)

You want to enjoy full protection and great functionality at a minimum weight? With this versatile 485 g bug net, you will no longer be bitten from below thanks to the smart 360° setup! It is compatible with standard hammocks (without spreader bars) and it fits all of our 3-meter-long hammock range.

The soft yet robust polyester mesh will even keep away the tiniest insects, snakes, rodents and other critters. The fully convertible top quickly opens thanks to double circular zippers — for extra freedom of movement or when you want to increase airflow. Put a shirt into the soft pouch and use it as a pillow. For starlovers, we recommend the black net.

Material	Polyester
Nettin	200 mesh openings/cm ²
Weight	485 g
Size	300 × 130 cm

- Double zipper opens entire top
- Includes adjustable ridgeline (not structural)
- 360° protection
- Extra fine mesh (200 holes/cm²)
- Washable at 30°C
- Mildew resistant
- Compact and lightweight

MOONQUILT ALLROUND

(TMMQA)



The Allround is the successor of our original Moonquilt and its name already gives it away. Besides being one of the best underquilts on the market, it offers a lot of functionality. In windy or freezing environments, you can zip up the recycled synthetic three-season underquilt. It so completely envelops you and your hammock. The two zippers and adjustable elastic shock cords let you conveniently adjust the level of insulation from within your hammock. Small pockets on the corners keep cords and mini carabiners neatly packed away when using it as a sleeping bag or blanket. In style, we also include a hidden pouch to keep essentials at hand.

Outer material	Recycled Crinkle Nylon 20D 44g/m ² Upcycled Crinkle Nylon 70D 64g/m ² (from hammock fabrics)
Inner material	
Weight	1280 g (1120 g quilt + 100 g hood + 60 g storage bag)
Size	200 × 140 cm
Filling	115 g/m ² 100% RPET Insulation ECODOWN by Thermore®
Moonquilt Temp. Range	5 20 °C
Sleeping bag Temp. Range	0 8 °C
	<ul style="list-style-type: none"> • Detachable hood machine washable at 30°C • Mildew resistant & water repellent • Underquilt & blanket use • Sleeping bag use (even around the hammock) • All-in-one solution



MOONQUILT COMPACT

(TMMQC)



The Moonquilt Compact is a minimalistic, yet comfortable and ready-to-use three-season underquilt. Fabricated mainly from recycled materials, it works brilliantly with standard hammocks and our Moonblankets.

Outer material	Recycled Crinkle Nylon 20D 44g/m ² Upcycled Crinkle Nylon 70D 64g/m ² (from hammock fabrics)
Inner material	
Weight	845 g (790 g quilt + 55 g bag + 60 g storage bag)
Size	210 × 135 cm
Filling	115 g/m ² 100% RPET Insulation ECODOWN by Thermore®
Moonquilt Temp. Range	5 20 °C

MOONQUILT PRO 650

(TMMQP650)



Outer material	20D Crinkle Nylon Downproof 20D
Inner material	Crinkle Nylon Downproof
Weight	740 g (695 g quilt + 45 g bag + 60 g storage bag)
Size	210 × 135 cm (115 cm in the middle)
Filling	NHD® certified in RDS® (650 fill power; 280 g down)
Moonquilt Temp. Range	2 20 °C



650 FP

- Ethically sourced high-performance duck down
- Compatible with standard hammocks
- Lightweight
- Resists wetting
- Maintaining the insulation properties and breathability even when moist
- Exceed 10.000 minutes on the industry IDFB 18 a ShakeTest. That's 7 days of constant exposure to water.

MOONQUILT PRO 850

(TMMQP650)



Outer material	20D Crinkle Nylon Downproof 20D
Inner material	20D Crinkle Nylon Downproof
Weight	795 g (750 g quilt + 45 g bag + 60 g storage bag)
Size	210 × 135 cm (115 cm in the middle)
Filling	NHD® certified in RDS® (850 fill power; 325 g down)
Moonquilt Temp. Range	-2 15 °C



850 FP

- Conscious high-performance duck down
- Compatible with standard hammocks
- Lightweight
- Resists wetting
- Maintaining the insulation properties and breathability even when moist
- Exceed 10.000 minutes on the industry IDFB 18 a ShakeTest. That's 7 days of constant exposure to water.

As the first company in Bali with a down-importing licence, we decided to get right to it and are proud to present this unique duo of down underquilts. They come in 650 and 850 Fillpower (Nikwax hydrophobic DWR and RDS certified) duck down and will surely keep you as warm and comfy during your adventures as only down can. The 650 model is rated until 2°C comfort (even for sensitive people), while with the Pro 850, you can hammock below freezing. To keep them lightweight, we decided to use our super soft 20D lightest fabric.

MOONBLANKET COMPACT

(TMBCOM52)



We are happy to announce our new range of Topquilts for next-level adventures with or without your hammock. Our colleagues in Bali affectionately refer to them as “Sombreros”. For clarity reasons, we still decided to name them Moonblankets. They are the counterpart or rather the addition to our Moonquilt range. At the same time, they are much more and it will often make sense to bring them along even if hammocking is not on the agenda.

Outer material	70D Crinkle Nylon (upcycled material from hammock fabrics)
Inner material	20D Crinkle Nylon
Weight	810 g (755 g blanket + 55 g bag)
Size	205 × 135 cm
Filling	115 g/m ² 100% RPET Insulation ECODOWN by Thermore®
Moonblanket Temp. Range	5 20 °C

- Lightweight and convertible design
- Machine Washable at 30°C
- High-performance materials
- Compatible with standard hammocks
- Resists wetting
- Maintaining the insulation properties and breathability even when moist



MOONBLANKET PRO 650



(TMBPRO650)

Outer material 20D Crinkle Nylon Downproof 20D
Inner material Crinkle Nylon Downproof 740 g (655 g
Weight blanket + 45 g bag + 60 g storage bag)
Size 205 × 135 cm
Filling NHD® certified in RDS®
(650 fill power; 280 g down)

Moonblanket
Temp. Range

2 | | | | | | | | | | 20 °C

- Lightweight and convertible design
- 650 Fillpower (Nikwax hydrophobic DWR and RDS certified) duck down
- High-performance materials
- Compatible with standard hammocks
- Resists wetting
- Maintaining the insulation properties and breathability even when moist
- Exceed 10,000 minutes on the industry IDFB 18 a Shake Test. That's 7 days of constant exposure to water.

MOONBLANKET PRO 850



(TMBPRO850)

Outer material 20D Crinkle Nylon Downproof 20D
Inner material Crinkle Nylon Downproof 795 g (750 g
Weight blanket + 45 g bag + 60 g storage bag)
Size 205 × 135 cm
Filling NHD® certified in RDS®
(850 fill power; 325 g down)

Moonblanket
Temp. Range

-2 | | | | | | | | | | 15 °C

- Lightweight and convertible design
- 850 Fillpower (Nikwax hydrophobic DWR and RDS certified) duck down
- High-performance materials
- Compatible with standard hammocks
- Resists wetting
- Maintaining the insulation properties and breathability even when moist
- Exceed 10,000 minutes on the industry IDFB 18 a Shake Test. That's 7 days of constant exposure to water.

ATTACHMENT KITS

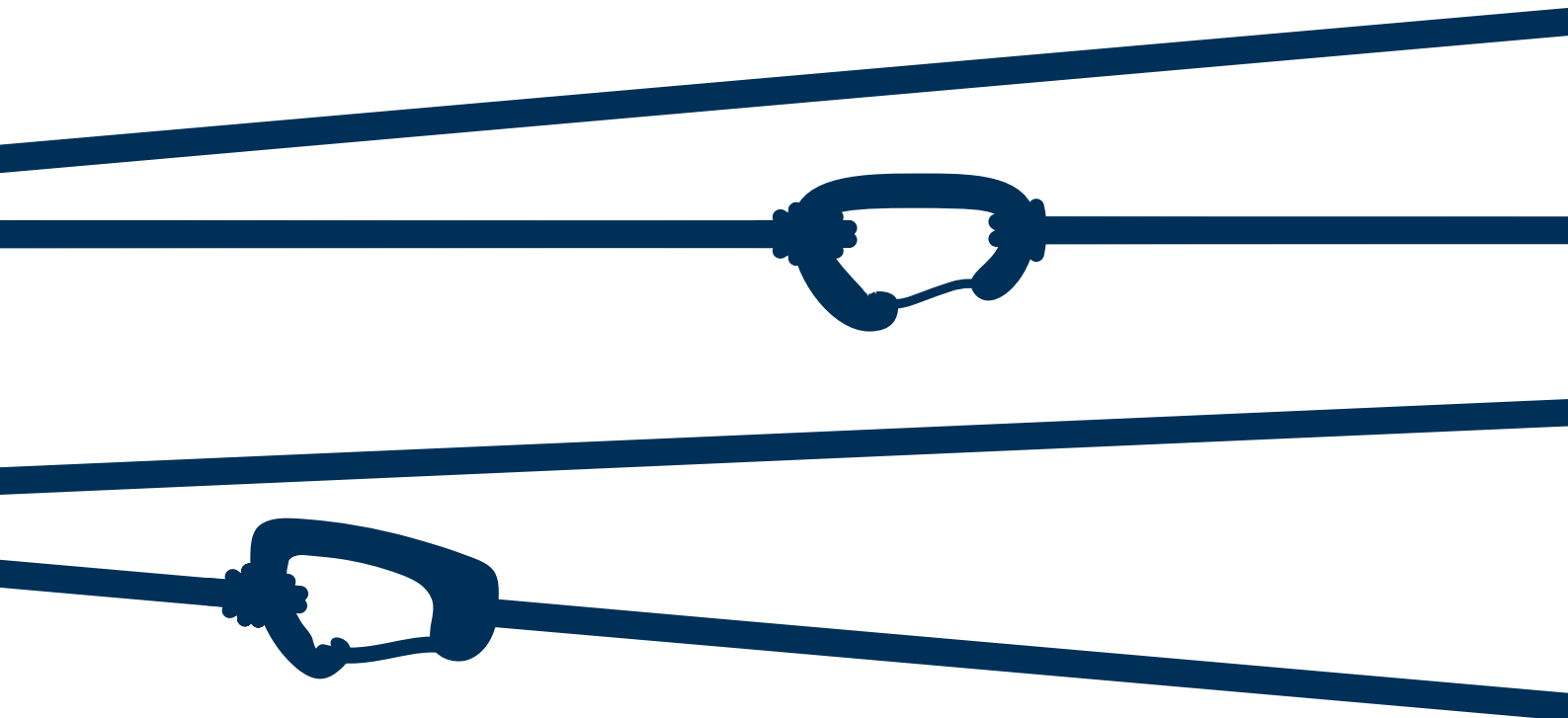

Nautical Rope Kit | Moon Straps | Lightest Strap |
Tree Friendly Extender | Tree Friendly Extender +

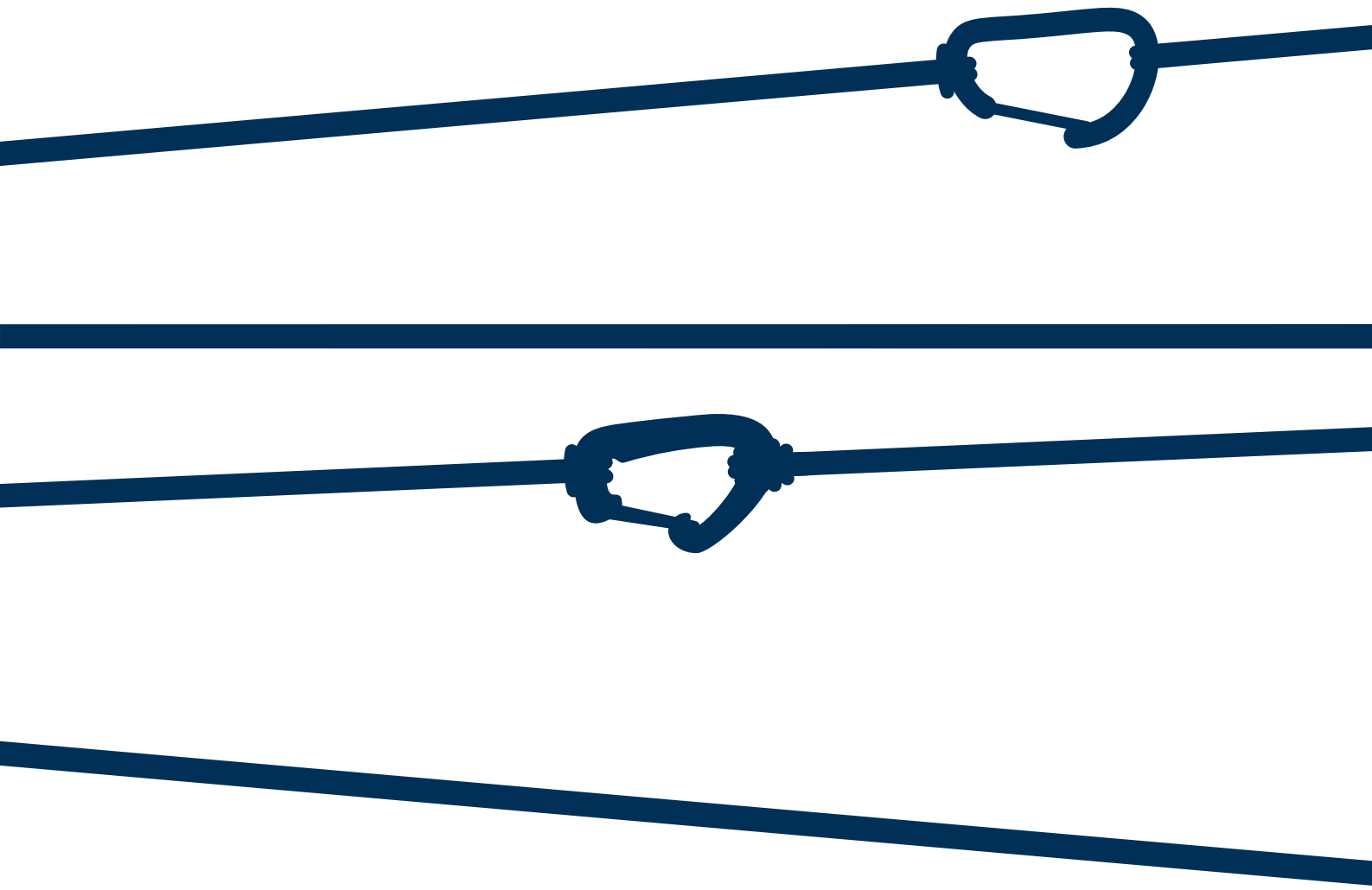

Hanging Kit | Carabiners: 10KN – 22KN – 6KN |
Accessory Carabiner | 2nd Tree

NAUTICAL ROPE KIT

(TMROPE)



Length	2.4 m
Diameter	Ø 5 mm (preknotted)
Weight	230 g
Max. load	200 kg
Material	100% Nylon
Breaking strength	>580 kg

Extremely durable, sturdy and safe rope hanging system. This minimalistic approach, invented by Ticket to the Moon more than 25 years ago, changed the hammock world forever. Anyone can hang a hammock in seconds, without tying any knots. But you can add more if you need to :)

Two pieces per pouch!

MOON STRAPS

(TMSTRAP)



Length	2.7 m
Width	2 cm
Weight	216 g
Max. load	300 kg
Material	100% Polyester
Breaking strength	>760 kg

This daisy-chain webbing is super strong, anti-slip, and extremely easy to use. Perfect for application on trees with a sensitive bark, or for hammocks that are used by more than one individual.

Two pieces per pouch!

LIGHTEST STRAP

(TMLSTRAP)



Full length	2.5 m
Tree-hugger	L: 0.9 m W: 2 cm
Rope	L: 1.6 m Ø 3 mm
Weight	110 g
Max. load	200 kg
Strap material	100% Polyester
Rope material	UHMWPE
Breaking strength	>400 kg

For only 110 g you get a tree-friendly and easy-to-use suspension solution. Perfect if weight matters! Made from UHMWPE rope to last. It even fits into the Express Bag of the Lightest Hammock and comes in a pair.

Two pieces per pouch!

TREE FRIENDLY EXTENDER

(TMTFE)



Length	1.55 m
Width	2 cm
Weight	105 g
Max. load	300 kg
Material	100% Polyester
Breaking strength	>760 kg

Has it ever happened to you that there was a lousy 10 cm missing between your hook and the ropes to hang your hammock? Sometimes trees are thicker and /or farther apart than you are prepared for. This is where the Tree Friendly Extender comes in. With a pair of tree-friendly polyester straps, it becomes easy to extend and /or upgrade your Lightest-, Moon Straps, or your Ropes.

Two pieces per pouch!



TREE FRIENDLY EXTENDER PLUS

(TMTFEP)



Full length	1.5 m
Weight	240 g
Max. load	500 kg
Strap material	100% Polyester
Breaking strength	>1200 kg

You want to be absolutely sure that the trees are only hugged and not hurt when installing your hammock? A pair of Tree Friendly Extenders are optimized for permanent setups, for trees with sensitive bark and for all those who would like to give extra love to trees. They are compatible with all standard attachment systems.

Two pieces per pouch!

HANGING KIT

(TMWALL)



Max. load
Material

200 kg
Stainless Steel

When back home from your travels, why not set up your hammock in the living room? A perfect place to read a book, plan your next trip, or simply enjoy some well-deserved relaxing time. Suitable for application on concrete, bricks and wood.



- Set of 2 hangers
- Screws, washers and fisher
- Slat-wall attachable packaging



NEW!

- 2x UHMWPE whoopie slings 2,3 m
- 3 x 25cm spiral Y-shaped pegs AL 7075
- 3 x 18cm Y-shaped pegs Aluminium
- 4x UHMWPE Loops 20cm
- Max. Weight 198g
- Min. Weight 98 g (2 pegs + 1 whoopie sling + 1 loop)



Dear bike-packers and cycling enthusiasts! This brand-new innovation might entirely change your next trip! All you need to get horizontal in your favorite travel hammock is a single tree or anchor point, your bike and the TTTM 2ND TREE. In almost no time, the pegs are safely placed in the ground, serving as an anchor. They are then attached to the bike in a stable triangle shape that will keep your setup stable and safe. Enjoy the flexibility and get the most out of your adventures!



"2nd Tree" can be used with a weak tree, your trekking poles, any wooden pole or even with a motorbike too!

UV SLEEVE

(TMHSUV)



Protects your hammock like a second skin from dirt, sun and wind. An essential, but optional accessory if you plan to leave it in UV light for an extended time. It keeps your hammock clean and stops the wind from flapping it around when not in use.

RIDGELINE

(TMRIDGE)



Material	PU coated 3 mm UHMWPE rope
Weight	80 g
Length	220 - 320 cm
Max. Load	200 kg
Breaking strength	450 kg



- UHMPE adjustable ridgeline 220 - 320 cm
- 2x 6 kN carabiners
- Organizer (5 compartments)
- Stainless-steel rings
- white mesh pocket (light diffuser)

With this structural and adjustable ridgeline kit, you will certainly hang like a pro and find your perfect position-everywhere and always! Installation is super easy, and you will sleep much better! A clever fusion of state of the art materials and locked Brummel eye splice loop and whoopie sling technology make this new accessory attractive for everyday use. With two 6 kN carabiners (7075 aluminium) it can be attached to the hammock and by simply holding and pulling on the handles, it can be shortened and extended to a maximum length of 320 cm.

PEGS SET

(TMPEG6Y)

NEW!



Length	18 cm
Width	12 mm
Weight	12.8 g / peg
Material	Aluminium

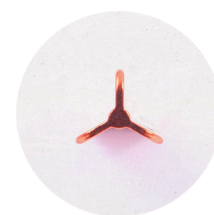

"Y-Shape" for extra strength!

Introducing our premium Y-Peg Set, expertly crafted for outdoor enthusiasts who demand reliability and strength in every piece of gear.



Each peg in this set is meticulously designed with a Y-shaped profile, ensuring superior holding power in a variety of ground types, from soft soil to harder, more challenging terrains.

- **Y-Shaped Design:** The unique Y-shape not only increases the surface area for a firmer grip in the ground but also provides excellent resistance against pulling out, making your setup more secure.
- **Durable Construction:** Made from premium aluminium, these pegs are built to last. Whether you're setting up a hammock tarp, a tent in the backyard or securing a shelter in the backcountry, these pegs are designed to withstand the elements.
- **Lightweight & portable:** At just 12.8 grams per peg, these are among the lightest on the market, ensuring your load is lighter without compromising on performance.
- **Multi-Purpose Use:** Ideal for camping, hammocking, hiking, backpacking, cycling, and any outdoor activity where a secure hold is essential.

CARABINER SET 10 KN

(TMBINER10)



Size	6 × 3.9 cm
Material	A7075 T6
Weight	14.5 g/pc
Closed 	10 kN
Opened 	3.5 kN



If you like to attach gear to your hammock, or feel the need for extra safety for your joyfully playing children, upgrade to our weight-rated carabiners. They were redesigned to even better secure your hammock while saving weight. More so, you will love the additional comfort of setting up your hammock.

Two pieces per pack!

CARABINER SET 22 KN

(TMBINER22)



Size	8.5 × 5.2 cm
Material	A7075 T6
Weight	34.4 g/pc
Closed 	22 kN
Opened 	7 kN



In case you feel that you want to have even more safety, you will like this carabiner. The extra strength allows you to effortlessly open the gate of the carabiner, while two dreamers are chilling in their hammock.

Two pieces per pack!

CARABINER SET 6 KN

(TMBINERo6)



Size	4.5 × 2.6 cm
Material	A7075 T6
Weight	6 g/pc
Closed 	6 kN
Opened 	1.5 kN

We designed this carabiner as the most lightweight option. Strong enough in any situation with its 600 kg closed gate rating, it has a custom eye-let for ropes like our UHMPE ropes. Suitable for our Lightest Hammock, it also works as a high-strength accessory carabiner.

Two pieces per pack!

ACCESSORY CARABINER SET

(TMBINERo3)



Size	4 × 2.5 cm
Material	A6061
Weight	3 g/pc
Closed 	30 kg

The perfect clips for securing smaller items like water bottles, knives, and flashlights to your Ticket to the Moon bag. These carabiners function well as key rings and more while accommodating guy lines.



One set contains 8 pieces.



TTTM hammock's
spare fabric



Nothing is left to waste!

Eco Bags | Backpacks | Sling Bags

WE UPCYCLE!

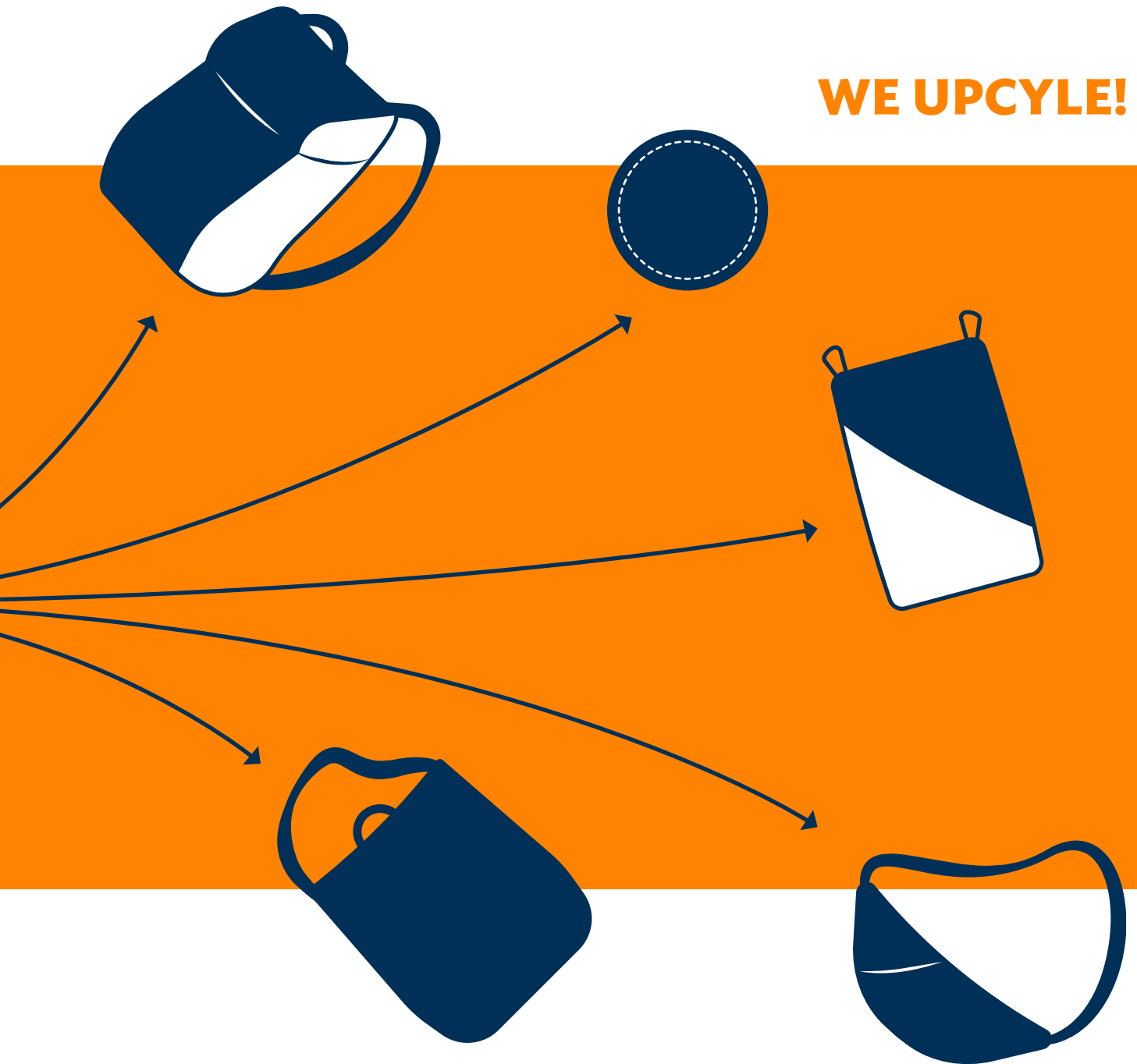

Travel Cubes | Wash Bag
Moondisc - Pocket - Ultimate



SMALL

Size	30 × 32 × 6 cm
Weight	40 g
Capacity	10 l
Carrying capacity	15 kg

This practical companion in a handbag format will always be with you and does a great job at keeping smaller accessories safe and easily accessible.



MEDIUM

Size	34 × 39 × 6 cm
Weight	55 g
Capacity	15 l
Carrying capacity	15 kg

This dynamic blend of storage capacity, durability and portability will make your everyday life so much more convenient. Taking your groceries home or transporting the essentials for a day by the lake is an absolute delight.



LARGE

Size	46 × 48 × 6 cm
Weight	75 g
Capacity	30 l
Carrying capacity	15 kg

This bag handles absolutely anything, including heavier items. Thanks to its lavish interior, there is no need to be selective about what you can carry. The wide handles sit nicely on your shoulders and do not cut in.



Spacious in use, tiny when packed!

SMALL
(TMEBS)



NEW! Black & Black
(TMEBS0707)



NEW! Mint & Jade Green
(TMEBS7173)



NEW! Hazelnut & Peach
(TMEBS7476)



NEW! Green Apple & Cloud
(TMEBS7577)

MEDIUM
(TMEBM)



NEW! Black & Black
(TMEBM0707)



NEW! Mint & Jade Green
(TMEBM7173)



NEW!  Army Green & Green Apple
(TMEBMR2475)



NEW! Light Purple & Plum
(TMEBM1978)



Unique Edition
(TMEBMU)



LARGE
(TMEBL)



Black & Black
(TMEBL0707)



NEW! Mint & Jade Green
(TMEBL7173)



NEW! Peach & Cloud
(TMEBL7677)



NEW! Burgundy & Dark Grey
(TMEBL3403)



Unique Edition
(TMEBLU)



ECO BAGS (TMEB_PR) PREMIUM

As we have introduced our Home and Garden Line, it is just natural that we have leftovers here as well. This allows us to give our Eco Bag range a massive upgrade in comfort and color choice, while the weight and packing size remain almost the same."



MEDIUM (TMEBMPR)

Size 34 × 39 × 6 cm
Weight 80 g
Capacity 15 l
Carrying capacity 15 kg



Terracotta Orange
(TMEBMPR4545)



NEW!
Sage Green
(TMEBMPR4747)



NEW!
Sparkling Gold
(TMEBMPR2323)

LARGE (TMEBLPR)

Size 46 × 48 × 6 cm
Weight 98 g
Capacity 30 l
Carrying capacity 15 kg



Terracotta Orange
(TMEBLPR4545)



NEW!
Sage Green
(TMEBLPR4747)



NEW!
Sparkling Gold
(TMEBLPR2323)

MINI BACKPACK

(TMMBP)



NEW!
Light Grey
& Dark Grey
(TMMBP0203)



NEW!
Dark Grey
& Mint
(TMMBP0371)



NEW!
Dark Green
& Jade Green
(TMMBP0573)



NEW!
Navy Blue
(TMMBP0606)



Black
(TMMBP0707)



Army Green
& Khaki
(TMMBP2422)



NEW!
Sky Blue
& Light Grey
(TMMBP3102)



NEW!
Royal Blue
& Aqua
(TMMBP3915)



NEW! Mint
& Ice Brown
(TMMBP7172)



NEW! Ice Brown
& Peach
(TMMBP7276)



NEW! Jade Green
& Sand
(TMMBP7370)



NEW! Plum
& Hazelnut
(TMMBP7874)



Unique
Edition
(TMMBPU)



It is a helpful companion that will save the day, every day! Launched back in 2012, our backpack has been refined several times, and now features supreme comfort and superb functionality.

- Large back pocket for small laptops (13")
- Contrast colour inside
- Eco-friendly
- Washable 30°C
- Foldable
- Top Pocket



Size	28 x 42 x 13 cm
Weight	140 g
Capacity	15 l
Carrying capacity	15 kg

We have upgraded the Mini Backpack pouch to be suitable in case of hanging on the (slat) wall or placing it in the new backpack dispenser. More so, we added an extra pocket for keys and sunglasses — yeeay!

BACKPACK PLUS

(TMPBP)



NEW!
Navy Blue
(TMPBPo6)



Black
(TMPBPo7)



NEW!
Light Blue
(TMPBPo9)



Burgundy
(TMPBP34)

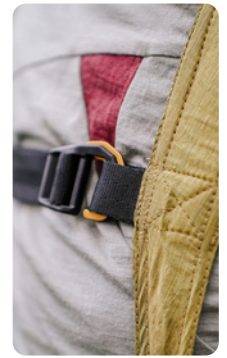

Chest strap feature!



Emerald Green
(TMPBP36)



NEW!
Ice Brown
(TMPBP72)



NEW! Plum
(TMPBP78)



Unique Edition
(TMPBPU)



After the extended success of the Mini Backpack, we developed a larger version with even more features. The Backpack Plus easily fits 15" laptops and has four practical compartments for flexibility

in organising. The secret pockets keep your valuables safe. The chest strap holds the shoulder straps in place to let you carry your belongings easily.

- Laptop compartment
- 1 main pocket
- Top pocket with zippable document compartment
- 2 hidden pockets
- Contrast colour inside
- Eco-friendly
- Washable 30°C
- Chest Strap
- Bottle holder
- Incl. accessory carabiner for keys

Size	29 × 45 × 15 cm
Weight	250 g
Capacity	25 l
Carrying capacity	15 kg



Spacious in use, tiny when packed!

BACKPACKS (TMBPR) PREMIUM

As we have introduced our Home and garden hammock line, is it just natural that we have leftovers of the premium material as well. This allows us to give our Backpack range a great upgrade in color choices and styles, while the weight and packing size of the product remains almost the same.



MINI BACKPACK PREMIUM

(TMMBPR)

Size 28 × 42 × 13 cm
Weight 155 g
Capacity 15 l
Carrying capacity 15 kg

- Hidden Pocket
- Eco-friendly
- Washable 30°C
- Foldable
- Top Pocket



Sparkling Gold
(TMMBPR23)



Natural Beige
(TMMBPR41)



Terracotta Orange
(TMMBPR45)



NEW! Ice Blue
(TMMBPR42)

BACKPACK PLUS PREMIUM

(TMPBPR)

Size 29 × 45 × 15 cm
Weight 280 g
Capacity 25 l
Carrying capacity 15 kg

- Laptop/document compartment
- 1 main pocket
- Top pocket with zippable document compartment
- 2 hidden pockets
- Eco-friendly
- Washable 30°C
- Chest Strap
- Bottle holder
- Incl. accessory carabiner for keys



Natural Beige
(TMPBPPR41)



Sparkling Gold
(TMPBPPR23)



Terracotta Orange
(TMPBPPR45)



NEW! Ice Blue
(TMPBPPR42)

SLING BAG

(TMSLB)



NEW!
Light Grey & Light Purple
(TMSLB0219)



NEW! ♻️
Dark Green & Jade Green
(TMSLBR0573)



NEW!
Black & Camo
(TMSLB07Camo)



Black
(TMSLB0707)



NEW! ♻️
Army Green & Brown
(TMSLBR2408)



NEW!
Sky Blue & Frosty Grey
(TMSLB3149)



NEW!
Sand & Chocolate
(TMSLB7004)



NEW!
Peach & Cloud
(TMSLB7677)



NEW!
Plum & Cloud
(TMSLB7877)



Unique Edition
(TMSLBU)



Weight	125 g
Material	70D Crinkle Nylon
Strap length	55 cm - 100 cm

- Foldable
- 4 zipped pockets
- Key-chain carabiner can be attached to 5 different locations
- Hidden pocket
- Contrast colour inside
- Wallet structure inside for perfect organisation
- Smartphone/sunglass pocket
- Partly upcycled material
- Hip bag use
- Can be worn below clothes
- Washable at 30°C

Whether on the daily commute, on a bike, for travelling or just the usual stroll, this take-it-everywhere Sling Bag has lots of storage space and numerous pockets to keep you organized, while a close-to-body ergonomic fit keeps you organized and comfortable. Made with a smile from upcycled materials.

SLING BAG PREMIUM

(TMSLBPR)



Weight	138 g
Material Strap length	70D Crinkle Nylon 55 cm - 100 cm

Experience style and practicality with our premium sling bags, designed for both the eco-conscious and the trend-savvy. These versatile, foldable sling bags come with four zipped pockets and a smartphone or sunglass compartment. You will love the cleverly designed wallet structure inside for impeccable organization. A key chain carabiner attaches to five locations for customizable utility, alongside a hidden pocket for securing valuables. The interior's contrasting color enhances visibility, making items easy to find, while the use of partly upcycled materials highlights our commitment to sustainability.

Whether worn under clothing for security or as a chic hip bag, this accessory adapts to your lifestyle. Washable at 30°C, it's easy to keep looking its best. Perfect for those who value both form and function, our sling bags are a smart choice for everyday adventures, combining convenience, security, and eco-friendly design in one compact package.

- Foldable
- 4 zipped pockets
- Key-chain carabiner can be attached to 5 different locations
- Hidden pocket
- Contrast colour inside
- Wallet structure inside for perfect organisation
- Smartphone/sunglass pocket
- Partly upcycled material
- Hip bag use
- Can be worn below clothes
- Washable at 30°C



NEW! Olive Brown
(TMSLBPR43)



Sparkling Gold
(TMSLBPR23)



Terracotta Orange
(TMSLBPR45)

TRAVEL CUBES

(TMTTC)

Travel smarter with our packing cubes! Maximize space in your bags, stay organized, and save time. Durable and stylish, they come in three practical sizes and work best in a set.

With the included carabiners they can easily be hung as needed. When you attach a rope or a strap, they also make a neat impression as a hand bags. A must-have for any trip!

- Eco-friendly
- Washable at 30°C
- Coconut zipper handles
- Practical top handle for versatile use
- Including 2 carabiners each
- Comes also in a Set of S, M and L



SMALL

Size	19 × 13 × 3 cm
Weight	40 g
Carrying capacity	0.7 l

MEDIUM

Size	30 × 18 × 5 cm
Weight	50 g
Carrying capacity	2.7 l

LARGE

Size	36 × 25 × 7 cm
Weight	66 g
Carrying capacity	6.3 l

TRAVEL WALLET

(TMW)



Size	15 × 10 cm
Weight	15 g

The travel wallet is a minimalistic gadget for safekeeping your valuables that comes with a mini carabiner so that everything stays in place.

SMALL (TMEBS)



Aqua
& Dark Grey
(TMTCS1503)



NEW! ♻️
Brown
& Army Green
(TMTCSRo824)



Burgundy
& Dark Green
(TMTCS3405)



Royal Blue
& Navy Blue
(TMTCS3906)



Unique Edition
(TMTCSU)



MEDIUM (TMEBM)



Aqua
& Dark Grey
(TMTCM1503)



NEW! ♻️
Brown
& Army Green
(TMTCMRo824)



Burgundy
& Dark Green
(TMTCM3405)



Royal Blue
& Navy Blue
(TMTCM3906)



Unique Edition
(TMTCMU)



LARGE (TMEBL)



Aqua
& Dark Grey
(TMTCL1503)



NEW! ♻️
Brown
& Army Green
(TMTCLR0824)



Burgundy
& Dark Green
(TMTCL3405)



Royal Blue
& Navy Blue
(TMTCL3906)



Unique Edition
(TMTCLU)



WALLET (TMW)



Aqua
(TMW15)



Burgundy
(TMW34)



Dark Grey
(TMW03)



Unique Edition
(TMWU)





NEW! Ice Blue
(TMWASH42)

This Wash Bag is the optimal size for all your toiletries and hygiene essentials! Easy full-open access with double zippers and multiple functional pockets (waterproof/mesh/nylon) for clever and personalised organisation.

You will love the detachable ultralight Wash Bag for mini adventures.

Size	24 × 15 × 8 cm
Weight (reduced)	200 (150) g
Carrying capacity	2.8l



NEW! Olive Brown
(TMWASH43)

Features:

- 13 pockets to organise your toiletry and first aid essentials
- flexible custom-made hook to fit almost any situation and carabiners
- Mesh/water and leakproof pockets
- organizer for classic and electric toothbrushes
- detachable mirror
- towel holder
- detachable 50 g ultralight (roll) bag for weekend trips with 4 pockets
- numerous elastic loops
- mirror



POCKET MOONDISC

(TMPDISC)



Light Blue
(TMPDISC09)



Purple
(TMPDISC30)



Burgundy
(TMPDISC34)



NEW! Sand
(TMPDISC70)

Diameter 26 cm
Weight 120 gr

ULTIMATE MOONDISC

(TMUDISC)



NEW!
Light Blue
(TMUDISC09)



Purple
(TMUDISC30)



Burgundy
(TMUDISC34)



NEW! Sand
(TMUDISC70)

Diameter 27.3 cm
Weight 175 gr



This travel and everyday toy is entirely hand-crafted from left-over parachute fabric and comes in two sizes. The Ultimate Moon Disc has approximately the same dimensions as standard ultimate frisbees. While the smaller version, the Pocket Moon Disc, is more compact and easier to throw for kids. It navigates through the air just as brilliantly as a professional hard-plastic disk, while it folds down surprisingly small and is insusceptible to deforming or breaking. The rim is filled up entirely with leftovers. Eco win!

LIFESTYLE PRODUCTS



Moonchair – Mini Moonchair |
Beach Blanket | T-Shirt

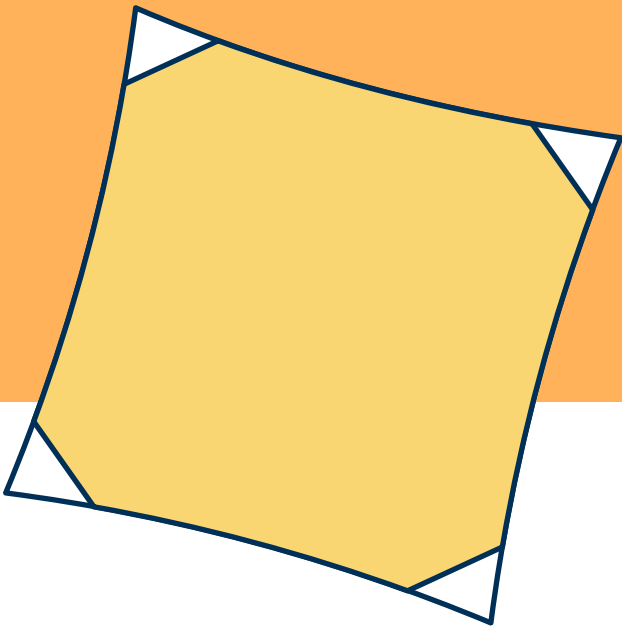
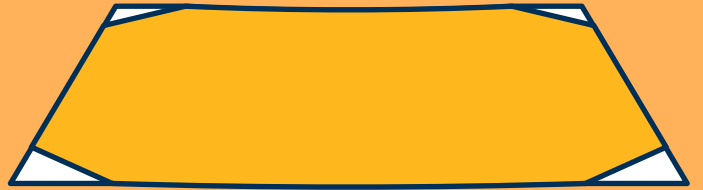

MOONCHAIR

(TMMC)



Black
(TMMC07)



NEW!  Army Green
(TMMCR24)



Burgundy
(TMMC34)



Emerald Green
(TMMC36)



Royal Blue
(TMMC39)



NEW! Sand
(TMMC70)



NEW! Plum
(TMMC78)

Can be packed!



Strong, durable and easy to bring along. A comfortable chair that releases all pressure from your spine. Thanks to its smart, stainless steel angle adjustment ring, you can find just the right position. The included length-adjustable footrest does its magic and lets you sink even deeper into relaxation mode. Using our signature nylon fabric in combination with aluminium tubing and quality webbing, this foldable chair is just ideal for gaming at home, as an exotic feature for your balcony, or to doze off after a day's hike under your favorite tree watching the sunset. The set is complete with its carrying bag, suspension rope and a 10 kN swivel-carabiner for hassle-free installation.

Max. load	120 kg
Weight	1700 g
Aluminium tubing	Ø 2.4 cm

- High-grade parachute nylon
- Skin-friendly
- Fast-drying
- Mildew resistant
- Adjustable seating position
- 2 side pockets
- Length-adjustable footrest
- Suspension rope length 2.5 m
- 360° Carabiner Swivel



MINI MOONCHAIR

(TMMMC)



A special smaller Moonchair aka. “portable carousel” designed for young dreamers up to 12 years of age. A great gift that will bring many years of joy. It comes with a carabiner and rope for easy and intuitive setup.

Max. load	60 kg
Weight	1000 g
Aluminium tubing	Ø 2.4 cm

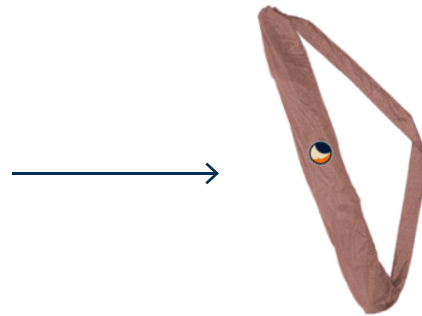

Take it anywhere!

- High-grade parachute nylon
- Skin-friendly
- Fast-drying
- Mildew resistant
- Adjustable seating position
- 2 side pockets
- Suspension rope length 2.5 m



NEW! Mint
(TMMMC71)



NEW! Peach
(TMMMC76)

BEACH BLANKET

(TMBB)



This convenient beach or picnic blanket provides an instant and welcoming sitting opportunity for those who want their feet ON the ground for a change. The integrated tent peg loops and corner pockets, for sand or rocks, make sure it always stays in place. You can also use the Beach Blanket as a sun shield or as a wind deflector by attaching ropes to the loops. Ticket to the Moon's Beach Blanket packs in a detachable, round pouch.

*Tent pegs are not included and sold separately

Size	213 × 213 cm
Weight	420 g



Aqua & Orange
(TMBB1535)



Emerald Green & Green
(TMBB3611)



NEW! Plum
(TMBB7878)



Can be packed into a pouch!

- High-grade parachute nylon silk
- Skin-friendly and spacious sitting option/ shade
- Fast-drying
- Mildew-resistant
- Compact and lightweight
- Corner pockets
- Compact pouch

T-SHIRT

(TMSHIRTW/
TMSHIRTM)

NEW!



Unleash your style with Ticket to the Moon's comfortable organic cotton t-shirts, a fusion of fashion and comfort tailored for both men and women.

Featuring a stylish, bold logo prominently displayed on the front, they capture attention and make a statement wherever you go - plus a smaller logo on the back. Crafted from soft, organic breathable cotton, these t-shirts promise all-day comfort and a perfect fit, making them the ultimate choice for those who value both style and comfort.

Female	XXS - XL
Male	S - XL
Weight	100 g

POINT OF SALE

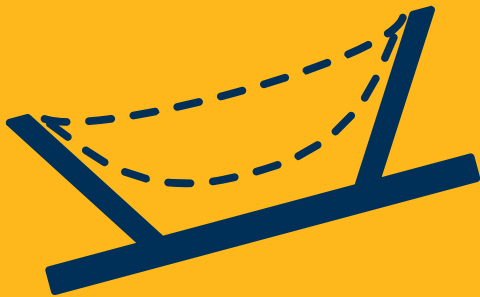

Moon Display | Slat Wall | Backpack Dispenser |
Mono Display | Hammock Hanger

Ticket to the Moon's presence spans across hundreds of global outlets, including upscale French boutiques, extreme sports retailers, and street pop-up stores, extending to festivals and events, captivating all with its distinctive displays.

Our point-of-sale (POS) materials, enriched with customer feedback, and display products, not only offer visual insights into their use but also boast a small footprint and artisanal natural finish, perfectly complementing our product lineup.

Below is an inspiration of all POS material, while you can scan the QR to see the **detailed version in our POS Catalog 2025** →

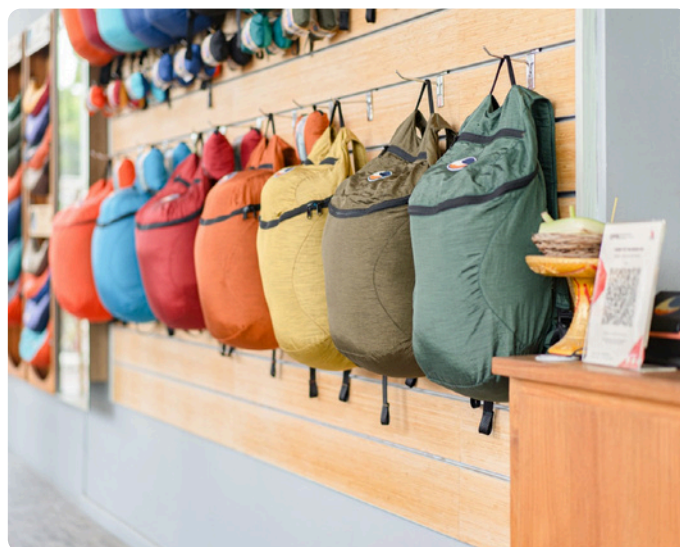

Clockwise, starting from top left: Rack, Backpack Dispenser, Slat Wall, Mono Display, Hammock Hanger;

COMMUNITY





SOCIAL & ENVIRONMENTAL PROJECTS

Over the past years, we have been very fortunate. We could drastically improve the local livelihood situation with our friends and partners in Sumba. In fact, things have improved so much that the TTTM Foundation's involvement in Sumba is gradually phasing out. We all are tremendously proud of the project's developments and are now eagerly following our Sumbanese friends' steps and standing by their side with advice upon request. With much excitement, we are now shifting our focus and energies to other selected social and environmental projects that we believe in and that are working towards similar goals to make the world a better place. We are an organisation with a strong commitment to sustainability and social responsibility. Therefore we feel a strong calling to give back to society and to support those in need. Amongst other activities, we have engaged in a couple of collaborations. As we are in the reorientation process of our social endeavors, let us know about any interesting projects or partners!

In addition to numerous collaborations, such as donating 200 sleeping bags to people experiencing homelessness in Austria—our second home—through the Caritas organization, our main partnerships include:

SOLEMEN

One of our current partner organisations is the humanitarian project "Solemen". Solemen is a non-profit organization based in Bali, Indonesia, that provides various forms of support to people with disabilities, chronic illnesses, and other life-threatening conditions. They assist individuals who are unable to afford medical treatment, rehabilitation, or other basic necessities. They also organize campaigns and events to raise awareness about various issues affecting the community. Ticket To The Moon recognizes the great work that Solemen is doing and wants to help them with their cause. Our company has provided printed eco-bags that are made from eco-friendly materials and are reusable. These eco-bags feature Solemen's and our company logo and are designed to help raise awareness about Solemen's mission and promote sustainable practices. Through this project, Ticket To The Moon hopes to encourage people to use eco-bags instead of single-use plastic bags. Plastic pollution is a significant environmental issue, and we must take steps to reduce our plastic usage. By donating eco-bags to Solemen, we aim to help reduce plastic waste while also supporting a great cause. We are proud to support Solemen's mission and

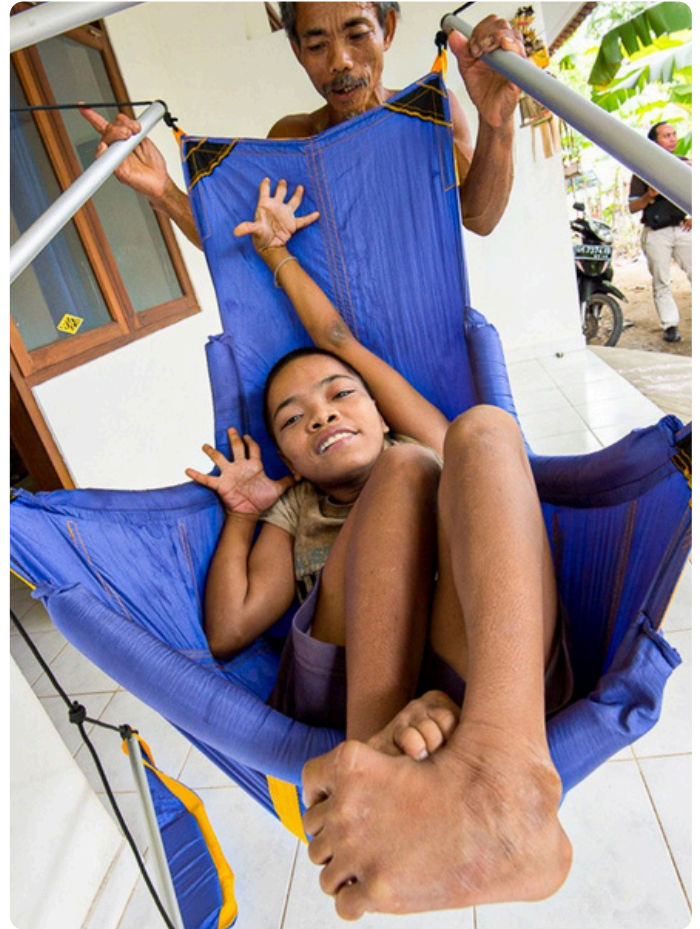

to help make a positive impact in the community. Our team believes that it is important to give back to society and we will continue to find ways to support worthy causes. Another way we support Solemen is by providing Moonchairs to disadvantaged families amongst many others with disabled children. These families were previously hidden away in a poor area of Denpasar without support or care from the outside. Through Solemen working closely with the government of Bali they all now enjoy new lives in Denpasar area of Renon in clean solid housing together with wheelchair access. The children benefit greatly from regular therapy, the provision of nutritionally balanced food and ongoing emotional support from the charity. Previously none of the children had the opportunity to experience play. But they are now even getting into all sorts of mischief with their newly discovered (and wild) swinging possibilities. What a joy!



PROJECT WINGS

Project Wings is a growing German NGO that is currently building the world's largest recycling village in Indonesia from 250 tons of plastic waste. They aim to tackle three major global issues: species extinction, tropical deforestation, and plastic pollution. The organization is implementing a self-sustaining system run by locals that combines environmental protection, nature conservation, and animal welfare. They use an innovative approach to turn plastic waste into Ecobricks, which are then used to construct affordable buildings. The NGO is also involved in protecting the rain forest, animal welfare, promoting alternatives to plastic and education. Their plans include building a sustainable

marketplace, sports grounds and organic restaurant. Project Wings collaborates with various partners and supporters to realize their vision. We support them with custom printed bags as a start to give to participants of round table meetings with NGO's and politicians as well as for funding activities in Germany to raise mindfulness for this important mission. We will support their crew with hammocks for the community patrol and for sleeping cabins for the team and supporters. We are currently in the planning phase of the next steps to raise awareness in Sumatra.

One man`s trash is another man`s treasure!



QUALITY CONTROL



After the workstation inspections, every product is checked again before leaving the production

Quality is our third pillar (where it gets really nerdy) besides acting **Ethical** and our **Community** approach. To follow the hammock flow, let us start with the incoming material. Upon its reception, samples of all security-relevant components are collected and taken into our testing room.

TESTING MACHINE



Product Testing Machine

Before entering production, they are torn by our tensile testing machine, while the measuring sensors record the parameters and save a protocol for our QC database. Some parts, like the S-Hooks for example, are tested constantly from each batch produced. For fabrics, we developed a unique testing procedure that makes sure that the fabric is suitable for hammocks and that the quality stays the same for every batch and colour. The sewing of our straps is monitored. We also test final products with scrutiny to ensure that you receive perfect products made with love in Bali.

TICKET TO THE MOON



Check out here for your
co-branding or
personalization requirements!

Headquarter Bali:
+62 361 419 288
office@tickettothemoon.com
tickettothemoon.com

Ticket to the Moon Europe:
+43 660 668 38 35
office.europe@tickettothemoon.com
eu.tickettothemoon.com